

magazine

2022



STREET
FAR



www.far.eu



BOOSTER UNITS FOR HEATING AND COOLING SYSTEMS

New line of booster units designed to be used on cooling and heating systems with 1" and 1" 1/4 connections and 125mm centre distance.

They are available in direct version and with mixing valve with 3-point or 0-10V actuator complete with:

- high efficiency pump with 6, 7, 8, or 10m head depending on the model
- shut-off valves with 0 ÷ 80 °C temperature gauges
- insulation shell
- connection fittings



Direct version
art. 2187



With 3-Point actuator
art. 2188



With 0-10V actuator
art. 2189

ASSEMBLED MANIFOLD FOR THE CONTROL AND THE SAFETY OF THE CENTRAL HEATING SYSTEMS

Threaded or flanged assembled manifold complete with accessories for the control and the safety of central heating systems with thermal power higher than 35Kw.

Main features:

- Designed for installation of safety valve
- Pressure safety switch
- Low limit pressure safety switch
- Safety thermostat with manual reset
- Temperature gauge
- Seat for fuel shut-off valve
- Control seat
- 3-way temperature gauge holder valve



1"1/4 - 1"1/2 - 2" Threaded Version
art. 2118



DN50 - D65 - DN100 Flanged Version
art. 2118



**DIRT SEPARATOR
FILTER**

**POCKET
FAR**



art. 2280

The POCKETFAR magnetic dirt separator filter, placed under the boiler, catches all the impurities and the iron particles that deposit inside the heating system over the time, thus safeguarding the components installed on the system.

INSTALLATION

PocketFAR should be placed on the return line before the boiler, in order to catch all the impurities that might damage the boiler and the pump.

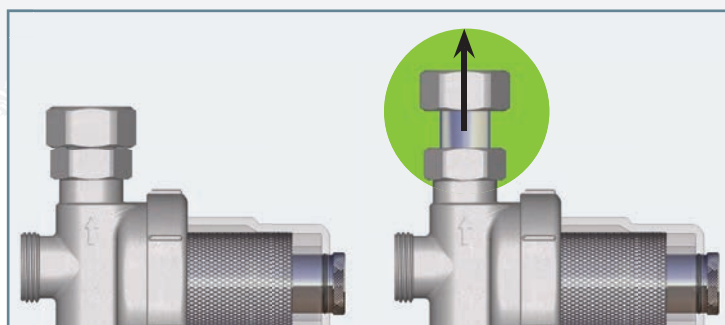

PocketFAR is equipped with an extensible joint (1cm extension) that makes installation easier.



**MAGNETIC
INSERT**

**FILTERING CARTRIDGE
700 µm filtration degree**

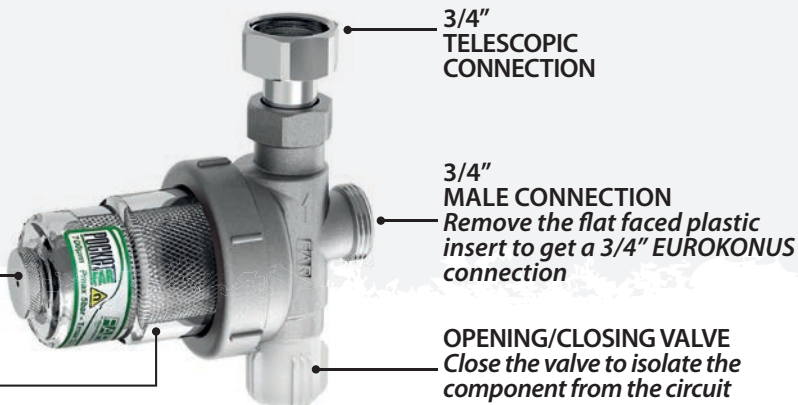

PolyFAR PROPORTIONAL POLYPHOSPHATE DOSING FILTER



art. 2410

PolyFAR is the new proportional polyphosphate dosing filter, useful to protect the domestic system from limescale and incrustations. The special proportional dosing system allows to correct the hardness of the water preserving the integrity of all installed components as well as the domestic appliances. The 100µm steel filter ensures better protection by removing suspended particulate in the water.

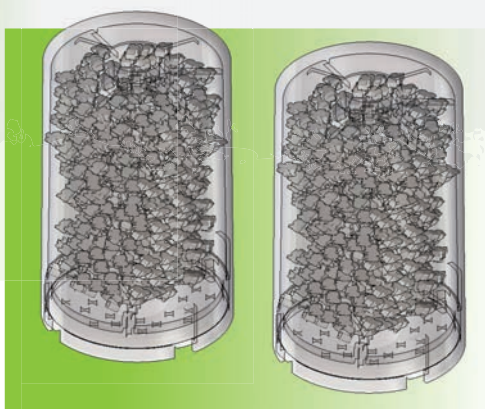

art. 9452

For proper operation of the system, check periodically the device and, if necessary, replace the refill cartridge with a new one.

OPERATION AND INSTALLATION OVERVIEW



PolyFAR dosing filter must be installed on the cold water pipeline upline of the domestic hot water supply system, to protect boilers, water heaters, washing machines and dishwashers. Thanks to the filter with steel mesh of 100 µm integrated in the cartridge, it is not necessary to install any additional safety filter to protect the hot water production system according to the UNI 8065 standard.

PolyFAR can be installed on both L-shaped and straight pipelines thanks to the special three-connection fitting.

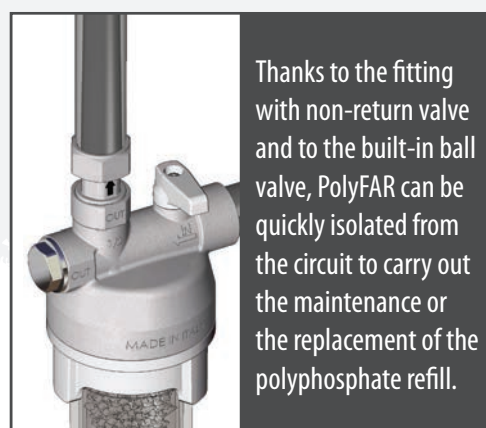

Thanks to the fitting with non-return valve and to the built-in ball valve, PolyFAR can be quickly isolated from the circuit to carry out the maintenance or the replacement of the polyphosphate refill.

SKUDOFAR *line*

The SKUDOFAR product line protects the system, ensuring the correct operation of all installed components.

By installing SKUDOFAR products you get advantages, such as:

- Consumption reduction
- Improved efficiency
- Noise reduction
- Long life of components
- Good treatment of incoming water and condensation

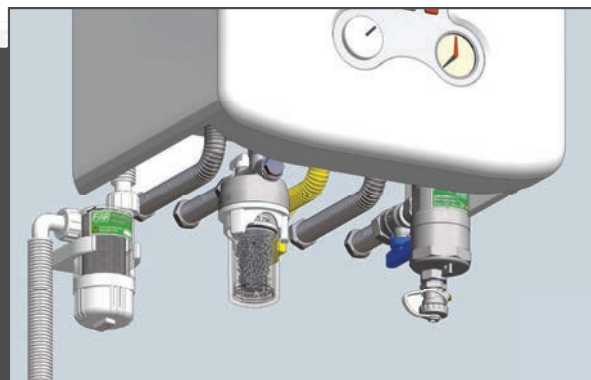

Installation example of the acid condensate neutralizer, the PolyFAR dosing filter and the CompactFAR dirt separator under a domestic boiler.

These products have been designed and manufactured following the right installation rules and the current standards.



ACID CONDENSATE NEUTRALIZER

Useful to treat the acid condensate produced by condensing boilers before directing it into the drain system. By neutralizing the condensation, the problem of corrosion on gutters, channels or drainage pipes is avoided.



POLYFAR POLYPHOSPHATE DOSING FILTER

Current regulations require the installation, at the entrance of the sanitary system, of a filter and a device that acts on the hardness of the water, reducing it, in order to eliminate limescale. PolyFAR is a device that combines two needs: it reduces the hardness of the water thanks to polyphosphates and stops impurities through a built-in filter cartridge.



FAR DEAERATORS

The removal of air bubbles in the heating and cooling circuits allows to reduce consumption, noise and preserve the integrity of the system components. The Standards in force provide the installation of special devices that allow the air to be separated and automatically discharged outside. FAR deaerators, installed near the heat generator, remove the air bubbles in the system thanks to the patented cartridge and the efficient swiveling discharge system.



FAR DIRT SEPARATOR WITH MAGNETIC INSERT

Magnetic dirt separators are essential components to ensure the efficiency of the heating and cooling systems and FAR offers a wide range. All models have a high separation efficiency of suspended particles thanks to the patented cartridge and to the combination of the magnetic and gravitational effect, preserving the integrity of all installed components.

SKUDOFAR CHEMICAL ADDITIVES

According to the current Standard, FAR offers a range of chemical additives for the water treatment for new and existing heating and cooling systems.

SKUD01
Liquid inhibitor protection against corrosion, encrustations, limestone, hydrogen formation and microbial growth.

SKUD03
Liquid cleaner removal of sludge, encrustations and debris restoring the correct operation of the system.

SKUD07
Liquid biocide control and removal of microbial, bacterial and algae growth.

SKUDOMONO
Single-dose additive protection against corrosion and algae growth.



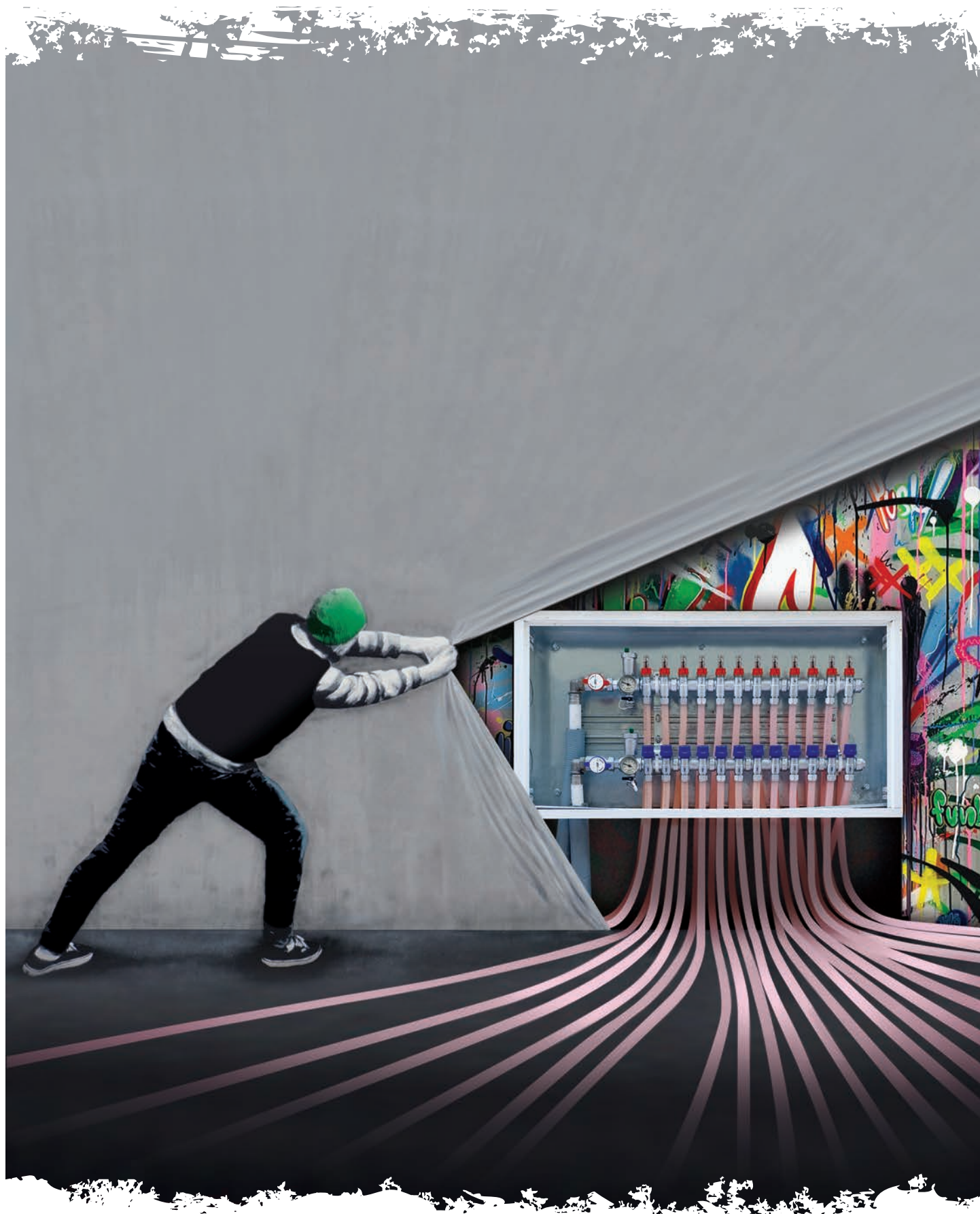

SET POINT REGULATING UNITS

FAR introduces two new set point regulating units for use on radiant panel systems.



art. 3493

Set point regulating unit complete with thermostatic mixer.

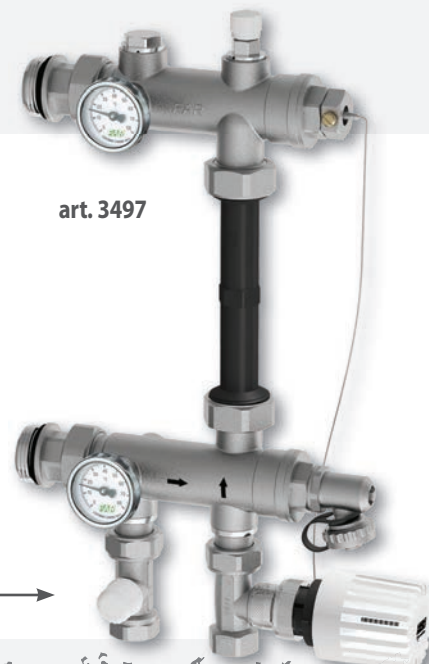

art. 3497

Set point regulating unit complete with thermostatic head with capillary sensor.

FAR thermo-electric manifolds are suitable for use on radiant panel systems. The presence of the flowmeter on each outlet allows to set the desired flow value in the circuit based on the project data. The flow rate value can be read on a special graduated scale. FAR thermo-electric manifolds are available with 1" and 1 1/4" male-female side connections, or with 1" flanged connections.

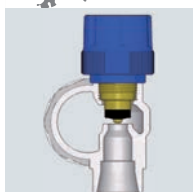

The special shape of FAR manifolds makes easier the flow passage, thus reducing flow resistances. This feature makes it possible to optimize the choice of the manifold diameter in relation to the number of circuits to be connected.



Depending on the version, FAR thermo-electric manifolds are available pre-assembled on brackets or pre-assembled in boxes, with or without set point regulating unit.



BEAUTY **FAR** DESIGNER COVER FOR INSPECTION BOXES

The BeautyFAR cover, available for "TUTTO" boxes Art.7420 (300 mm) and Art.7425 (400 mm), can be used to replace the existing cover supplied together with the box, to satisfy the most modern design requirements.

The BeautyFAR covers are made of plastic material with glossy white, matt white, matt black and metallic grey finishes, to ensure an excellent designer solution and offer a wide variety of choice to the end user.

The opening and closing magnetic system makes easier and speeds up the inspections of the manifold inside the box.

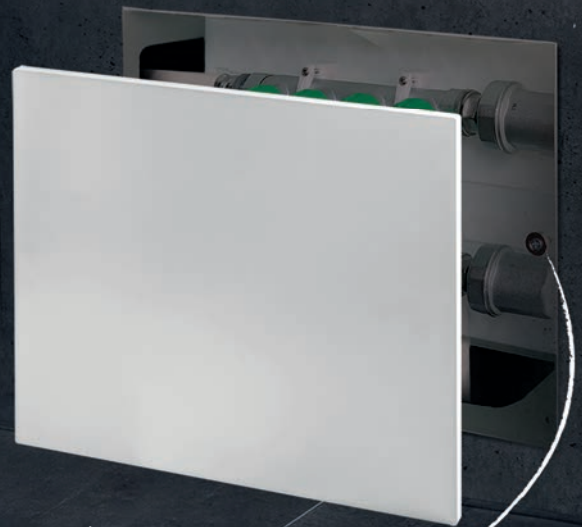

NICE DESIGN

MAGNETIC FIXING SYSTEM

SPRING TO ADJUST THE DEPTH

MAGNETIC DISK

FIXING SCREWS

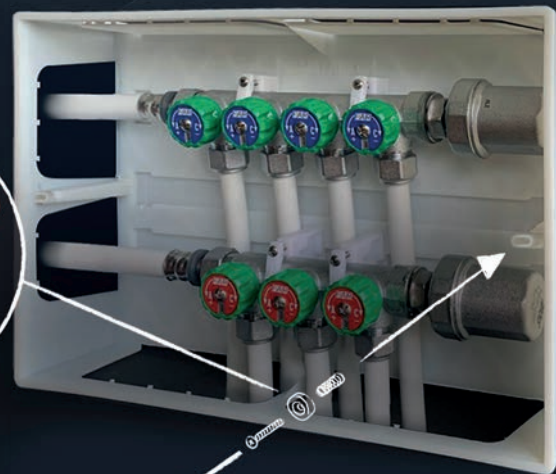

SUITABLE FOR "TUTTO" BOXES RANGE

AVAILABLE FINISHING



- MATT BLACK
- METALLIC GREY
- GLOSSY WHITE
- MATT WHITE



Top FAR

TopFAR thermostatic valves stand out for their linear, sober and refined shape and satisfy the most modern design requirements. The new MATT WHITE and MATT BLACK finishing integrate those already available to complete the range.



The thermostatic head is provided with a liquid sensor, which detects temperature variations and opens or closes the valve accordingly. It has a regulating scale numbered from 1 to 5 to permit selection of the desired temperature.

The thermostatic head is available in 5 different finishing: white, matt white, black, matt black and glossy chrome.

In order to complete the range and satisfy the multiple design solutions, FAR has created the new range of wall covering plates available with the same finishing as the thermostatic head.



WALL COVERING
PLATES

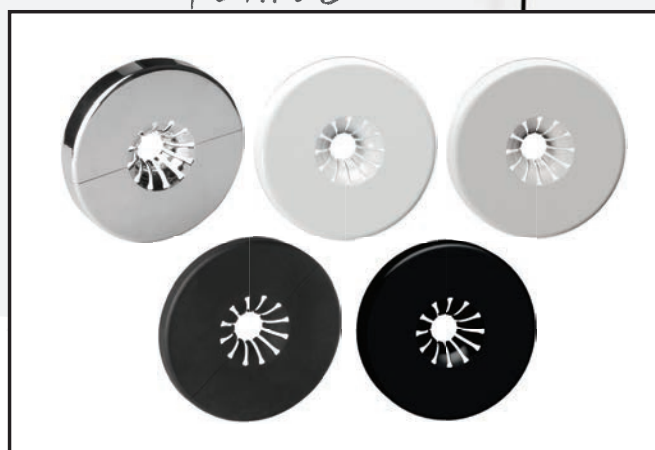

THERMOSTATIC HEADS



MAGNETIC STRAINERS WITH STRAIGHT AND SWIVELING CONNECTIONS

FAR swiveling and straight strainers guarantee an accurate filtering of sanitary water, preserving over time the functioning and the duration of the installed components. The incoming water follows a guided path entering the filtering net from above and then moves in a radial direction, getting rid of impurities. The particles thus stick to the net or fall down,

accumulating near the drain valve. The ferrous particles are attracted downwards by the magnetic insert placed on the bottom. Both versions are also available without magnetic insert. All versions are available with M-M, M-F, F-F connections and already complete with pressure gauge if necessary.

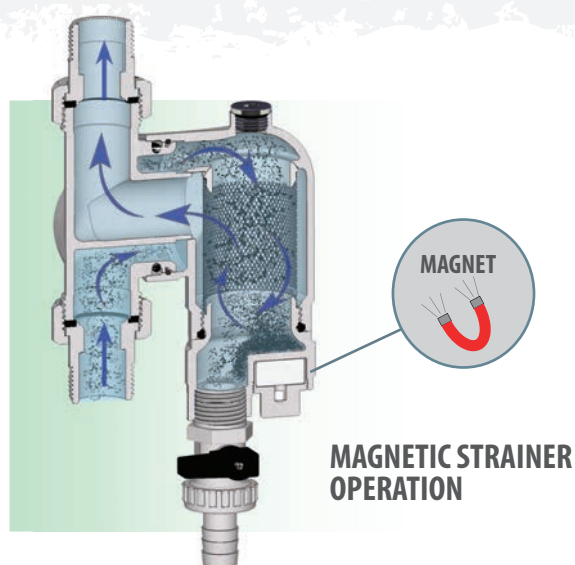

PRE-ADJUSTABLE PRESSURE REDUCING VALVES

FAR offers a new range of pre-adjustable pressure reducing valves.

These new pressure reducing valves are available in 1/2" and 3/4" M-M sizes, with the possibility of regulating the downstream pressure from 1 to 6 bar.

They can be used on sanitary systems with PN 25bar and Tmax 75 °C.

A particular version with inlet filter allows to eliminate suspended particles and guarantee a better operation of the system.

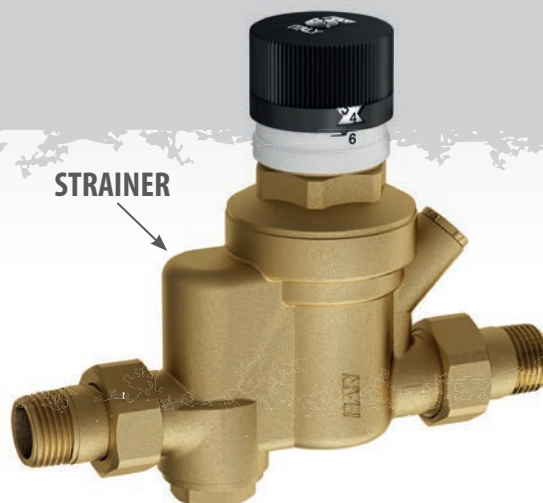



PRESSFAR THE UNIVERSAL SOLUTION

Brass Body

- Internal machining which allows full bore flow and minimal pressure drops.
- Profile designed with safety calibration.

TEA® Surface Treatment

- To grant high water quality.
- Corrosion protection in underfloor systems.

Flat EPDM Washers

- Larger contact surface to grant a better seal.
- Designed to avoid the possibility of being damaged when inserting the pipe.

Plastic ring in different colors

- Pipe thickness easy to identify.

Stainless steel bush

- Long-lasting seal.
- Pipe position easy to check.



The universal system of press fittings for multilayer pipes, suitable for pressing with three different profiles: TH-U-H



RING COLOR	MULTILAYER PIPE SIZES									
	14x2	16x2	18x2	20x2	-	26x3	32x3	40x4	50x4	-
GREY	14x2	16x2	18x2	20x2	-	26x3	32x3	40x4	50x4	-
WHITE	-	16x2,25	-	20x2,25	-	-	-	-	-	-
GREEN	-	-	-	20x2,5	25x2,5	-	-	40x4,5	50x4,5	63x4,5

PRESS FITTINGS FOR GEOTHERMAL AND DISTRICT HEATING SYSTEMS



A new system of press fittings for standard SDR11 pipes in PE100 or PEX, suitable for use in geothermal and district heating plants. The fittings are made of brass with stainless steel bush and EPDM gaskets. They are guaranteed up to a pressure of 16 bar and a temperature of 95°C.



Available sizes (according to the version):

- 25x2,3
- 32x2,9
- 40x3,7
- 50x4,6
- 63x5,8



The press fitting system is compatible with profiles: TH - U - H



WRAS
APPROVED
PRODUCT



art. 2895



art. 2896

WATER HAMMER ARRESTER

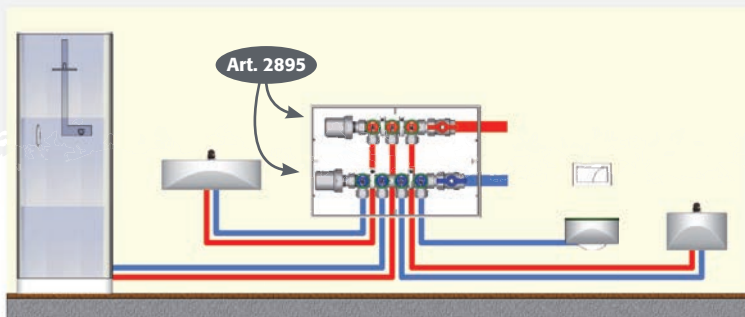

art. 2896

The water hammer arrester can be installed on distribution manifolds or directly on each circuit (e.g. wash-basin).

The water hammer arrester for domestic services mitigates the effect of overpressure, preserving the correct functioning of the components in the system. The device can withstand a maximum pressure of 50 bar and a maximum working temperature of 90°C.

COMPONENTS FOR SOLAR SYSTEMS

solarfar

Motorized solar units with or without thermal integration

Solar units with thermostatic diverter

Automatic air vent valves

Thermostatic mixers

Deaerator

Fittings

Safety valves and pressure and temperature relief valves



art. 3090



art. 3091



art. 3092



art. 2068



art. 3955



art. 2252



art. 5870



art. 2009

SO **FAR** SO GOOD
 flow evolution



FAR - Main factory in Gozzano (NO)

FAR - Brass machining department in Gozzano (NO)



FAR - Factory in San Maurizio d'Opaglio (NO)



www.far.eu

